

MPVW-X64U-PPV2 Video Wall Mount

Video wall mount with push in, pop out technology

Best In Class Mounting Solution

- Full featured video wall solution and pull out mount
- Up to 3" of depth adjustment to address uneven walls
- 11.00" pull out extension from wall for easy wiring
- Push in-Pop out™ Technology to access middle displays of matrix
- Integrated dual keyed lock system
- Vertical adjustment and leveling
- Plumb adjustment and Lateral shift

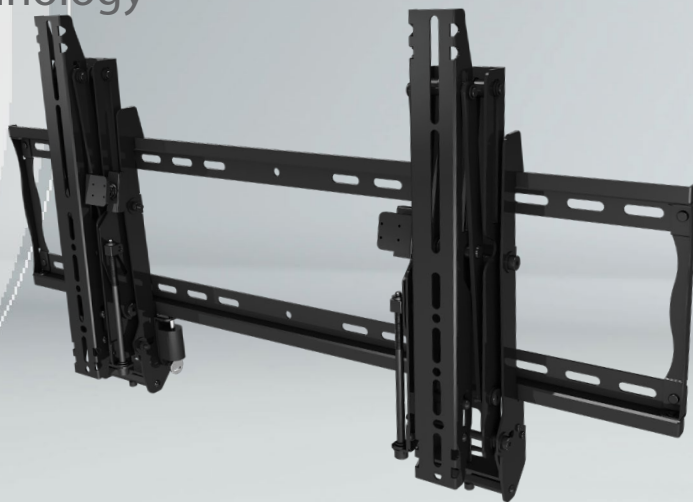

* Display size is meant as a guide – Compatible display sizes can be larger or smaller depending on the VESA and weight of the display.

Model	Display Size	VESA	Depth	Max Load
MPVW-X64U-PPV2	40" or larger	Up to 600x400	3.85" Min - 6.8" Max	150 lb

SERVICE MODE

11" Extension From Wall

Gives installer 11" of clearance for wiring and service.

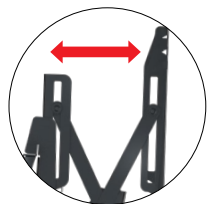

PUSH-IN/POP-OUT TECHNOLOGY

Secure in Place or Extend with a Push

Single displays pop out or lock in place with a gentle push for ease of access without disturbing video matrix



LATERAL SHIFT

Along the Wall Plate

Laterally display slide during installation. Amount of lateral shift depends on the VESA hole pattern of the display.

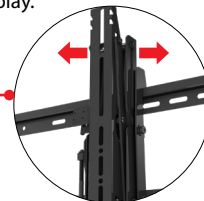

Depth Adjustment

3" Depth Micro-Adjustment

In addition to the 4-corner plumb adjustment adds an independent micro-adjustment for regulating depth of the display relative to the wall.

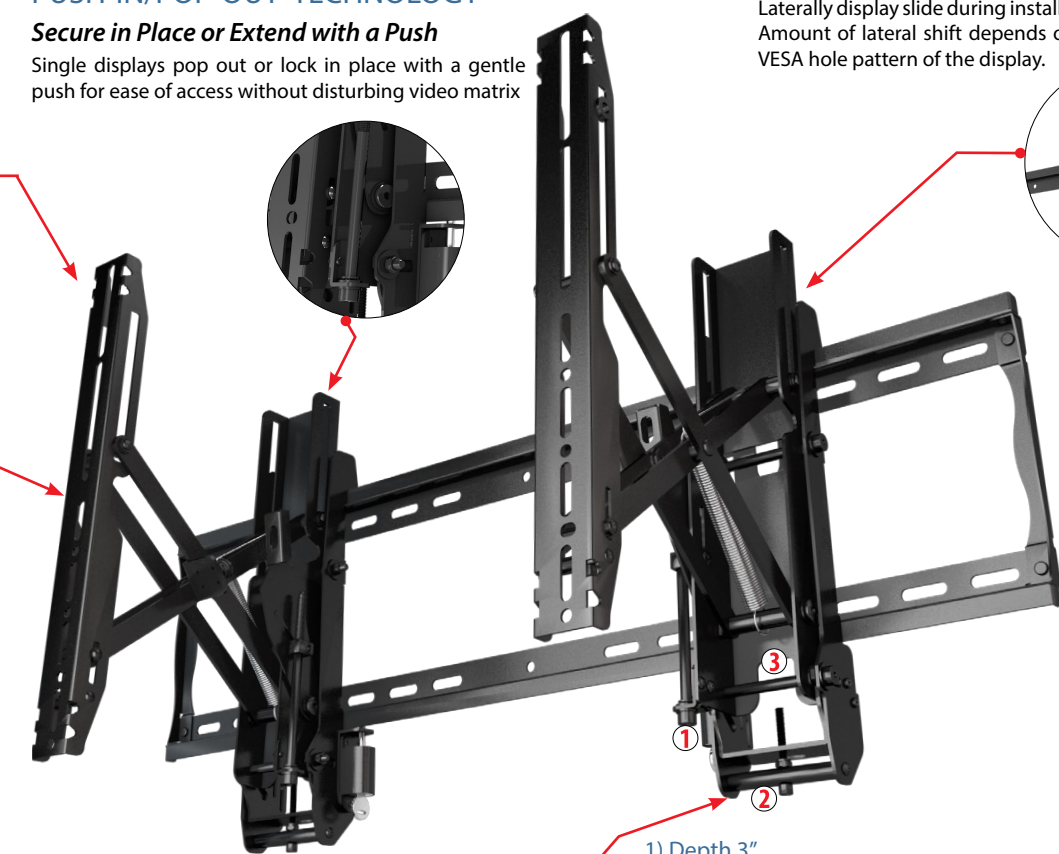
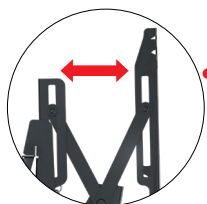

- 1) Depth 3"
- 2) Plumb +/-0.5"
- 3) Leveling +/-0.5"

LOCK & KEY SECURITY

Proprietary Dual Lock System

Crimson-specific keyed locking system with keys that can not be duplicated.

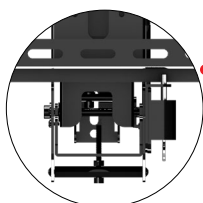

ADJUSTMENTS IN ONE LOCATION

6 Conveniently Located Adjustment Points

All 6 micro-adjustment points are located on the bottom of the mount for easy access. 6mm standard hex driver is included.

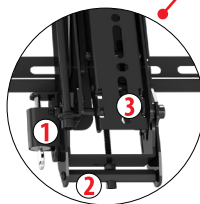

MPVW-X64U-PPV2 Video Wall Mount

Video wall mount for 37-75" Displays*

Mustang AV
www.mustangav.com



Video Wall mount with Push in, Pop out Technology and 6 points of adjustment for easy alignment. The third generation of our best in class video wall mount system builds on proven previous models to deliver even more points of adjustment as well as increased adjustment range, with professional installers in mind. In addition to vertical, horizontal, and plumb adjustments, the MPVW-X64U-PPV2 allows for nearly 3" of depth micro-adjustment for ultimate ease in video wall alignment especially in instances where walls are uneven.

Attribute	Value
Recommended Display Size *	37" – 75"
Orientation	Landscape
Weight capacity	150 lb (68kg)
Max mounting pattern	783x402mm
VESA mounting patterns	200x200mm through 600x400mm
Post-installation leveling	+/- 0.5" (1" total)
Plumb Micro-Adjustment	+/- 0.5" (1" total)
Depth Micro-Adjustment	2.95" total depth
Depth from wall	3.85" min (98mm) to 6.80" (173mm) max
Extension	11" extension from wall during service
Security	Proprietary keyed alike lock and key system
Packaging Dimensions	35.5" x 12.75" x 4.75"
Product Weight	22 lb
Construction	High-grade cold rolled steel
Product finish	Scratch resistant epoxy powder coat
Color	Black
Model number	MPVW-X64U-PPV2
Warranty	5 year limited

